

NOTE:

----- = WHITE
 _____ = BLACK

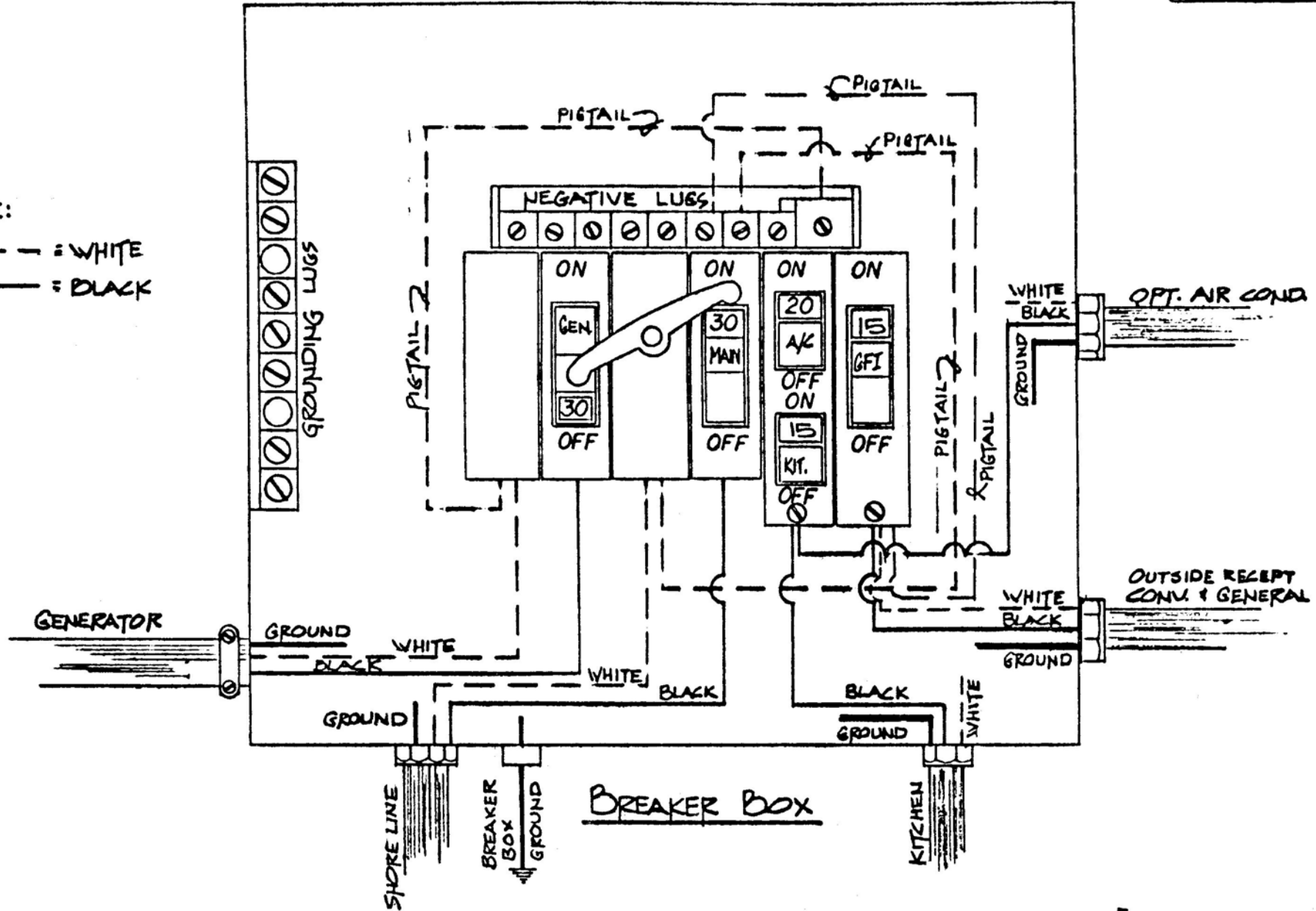

ELECTRICAL

COACHMEN INDUSTRIES, INC.

					MODEL	ALL TRANSMODE MODELS	DATE	3-8-76	DWG. NO.	J-EL-274
					SUBJECT	A BREAKER BOX WIRING	SCALE	NO SCALE	SHEET	DWG BY
									OF	1
										GRIFIN

SYM	REVISIONS	CHANGE NO.	DATE	BY	SER. NO.	THRU	APP. BY
-----	-----------	------------	------	----	----------	------	---------

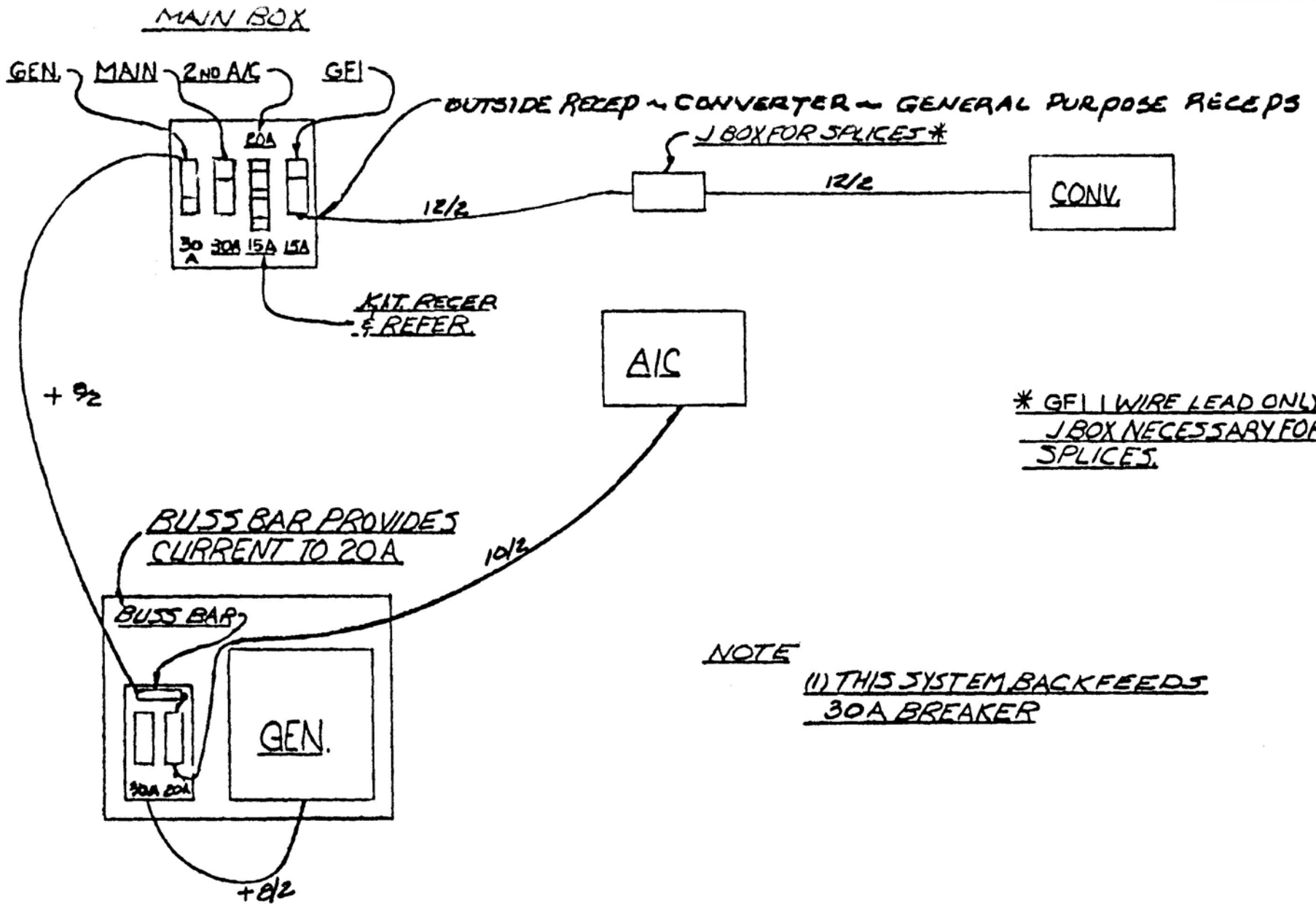

ELECTRIC

COACHMEN INDUSTRIES, INC.

26RB
MODEL 265B TRANS MODE

DATE
12-6-75

DWG. NO.
J-EL-174

SUBJECT BREAKER BOX
HOOKUP FOR OPT. 2ND A/C.

SCALE
NONE

SHEET /
OF 1

DWG BY
R. SARASON

STM

REVISIONS

CHANGE NO.

DATE

BY

SER. NO.

THRU.

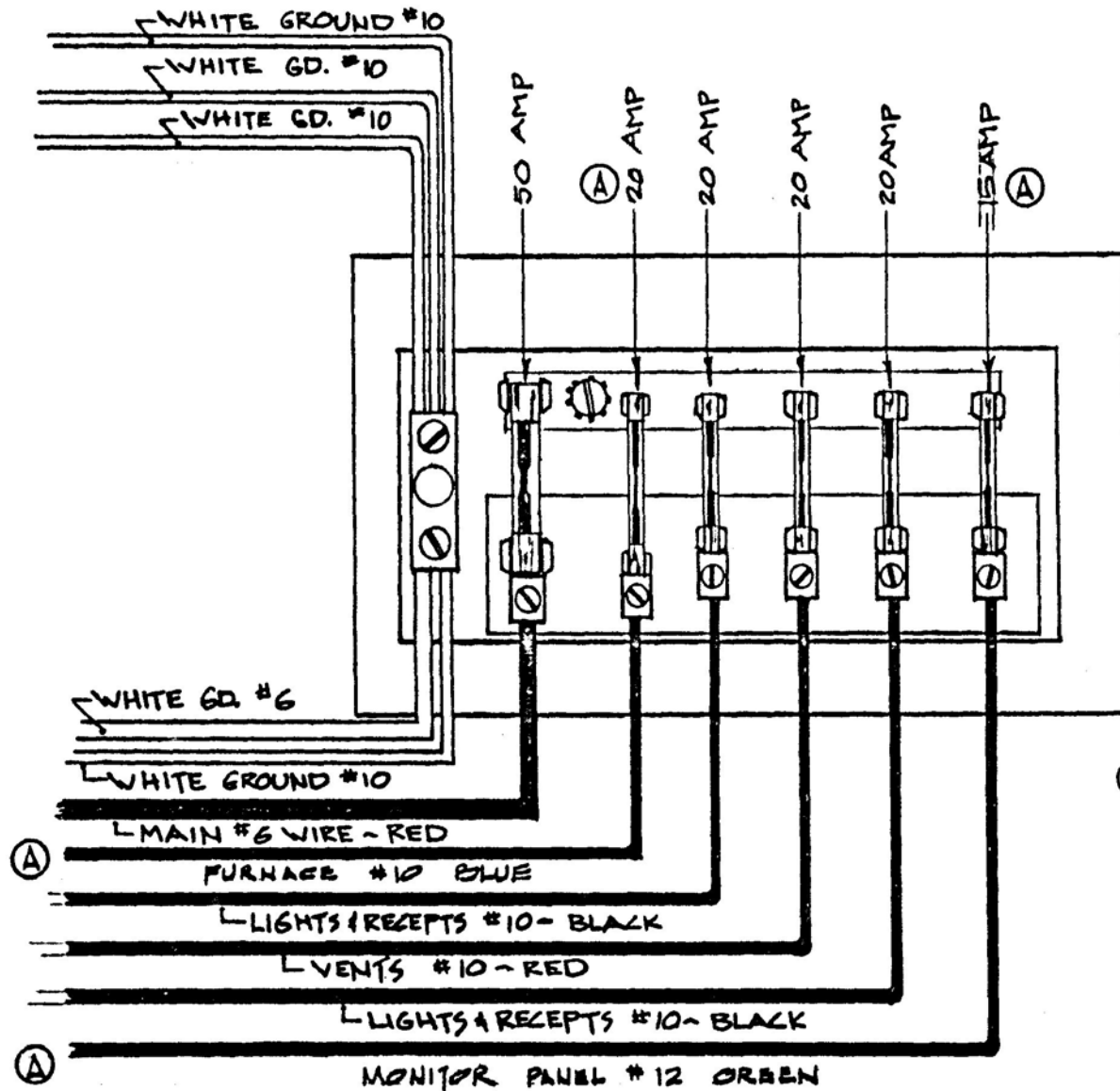

Ⓐ NOTE:
 TRIAD-UTRAD FUSE BLOCK
 NUMBER 60-5220-15

ELECTRICAL

COACHMEN INDUSTRIES, INC.

				MODEL	ALL TRANSMODES	DATE	5-17-76	DWG. NO.	J-EL-402-A
				SUBJECT	DISTRIBUTION BOX	SCALE	---	SHEET 1	DWG BY
								OF 1	GRIFFIN
SYN	REVISIONS	CHANGE NO.	DATE	BY	SER. NO.				
A.	REV. FURN & MONITOR PAN. HMK-UPS		4-6-77	JFS.					

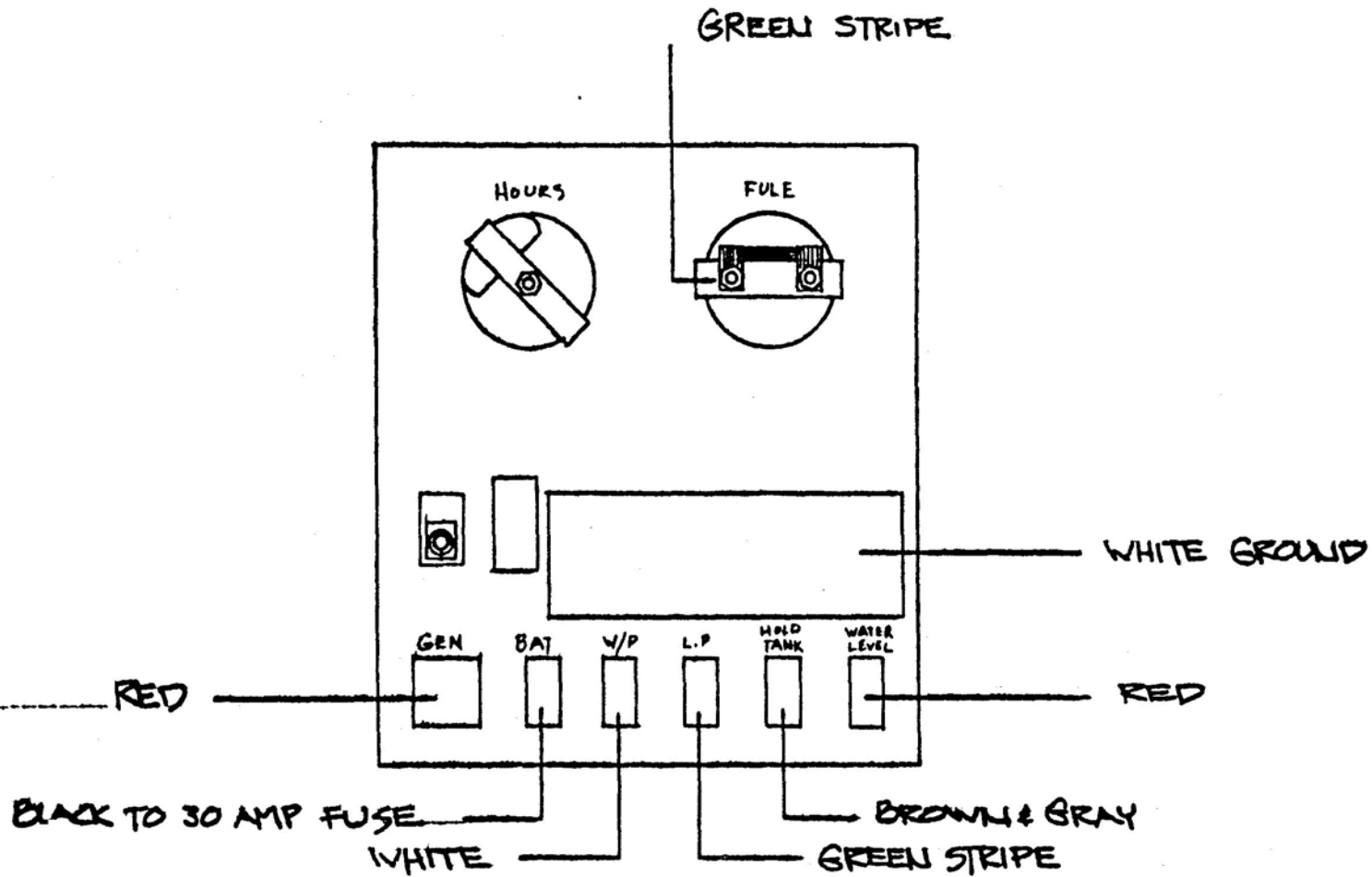

ELECTRICAL

COACHMEN INDUSTRIES, INC.

MODEL	ALL TRANSMODES	DATE	10-13-76	DWG. NO.	J-EL 756
SUBJECT	MONITOR PANEL WIRE	SCALE		SHEET	1
				OF	1
				DWG BY	GRIFFIN

BY	REVISIONS	CHANGE NO.	DATE	BY	SER. NO.	THRU.	APPD. BY
----	-----------	------------	------	----	----------	-------	----------

CIRCUIT #2 LIGHTS & RECEPTS - BLACK
 AMP LOAD
 1.4 PER 12V BULB.

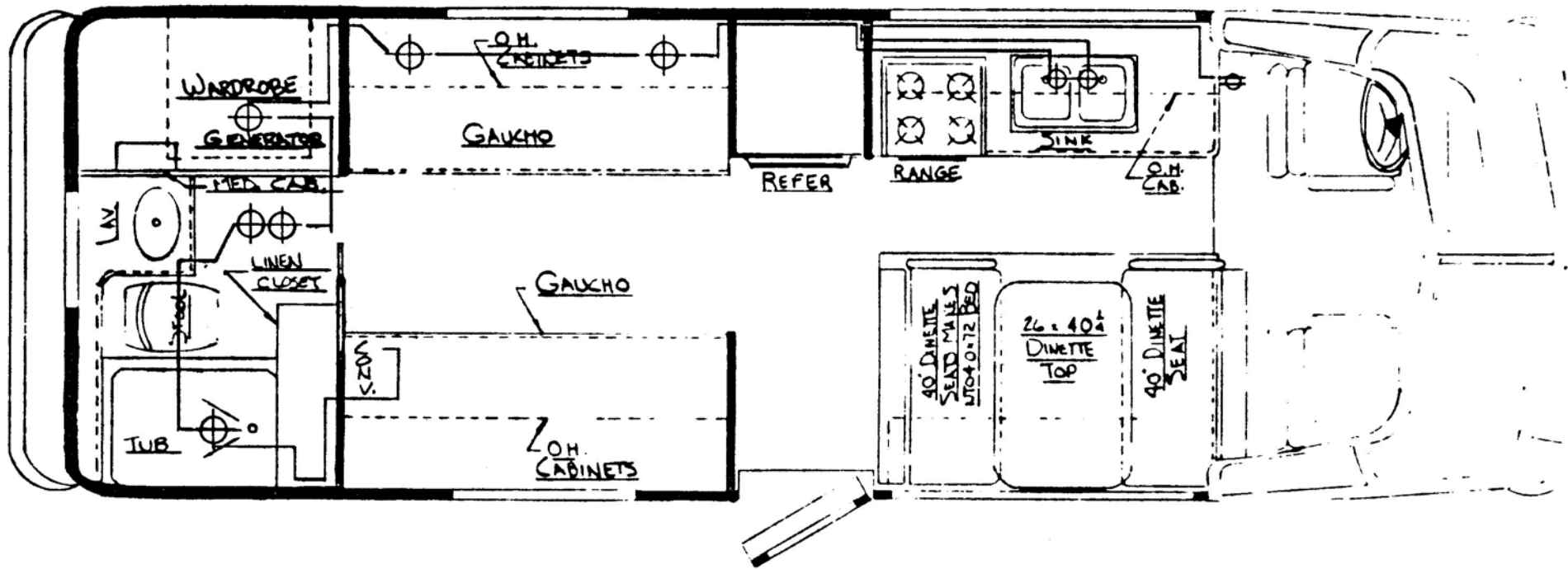

ELECTRICAL 12V.

COACHMEN INDUSTRIES, INC.

MODEL	26' RB TRANSMODE	DATE	3/1/76	DWG. NO.	J-EL-254
SUBJECT	12V. CIRCUIT #2	SCALE	NO SCALE	SHEET	DWG BY
				OF	GRIFFIN

SYM	REVISIONS	CHANGE NO.	DATE	BY

SER. NO.	THRU	APPD. BY
----------	------	----------

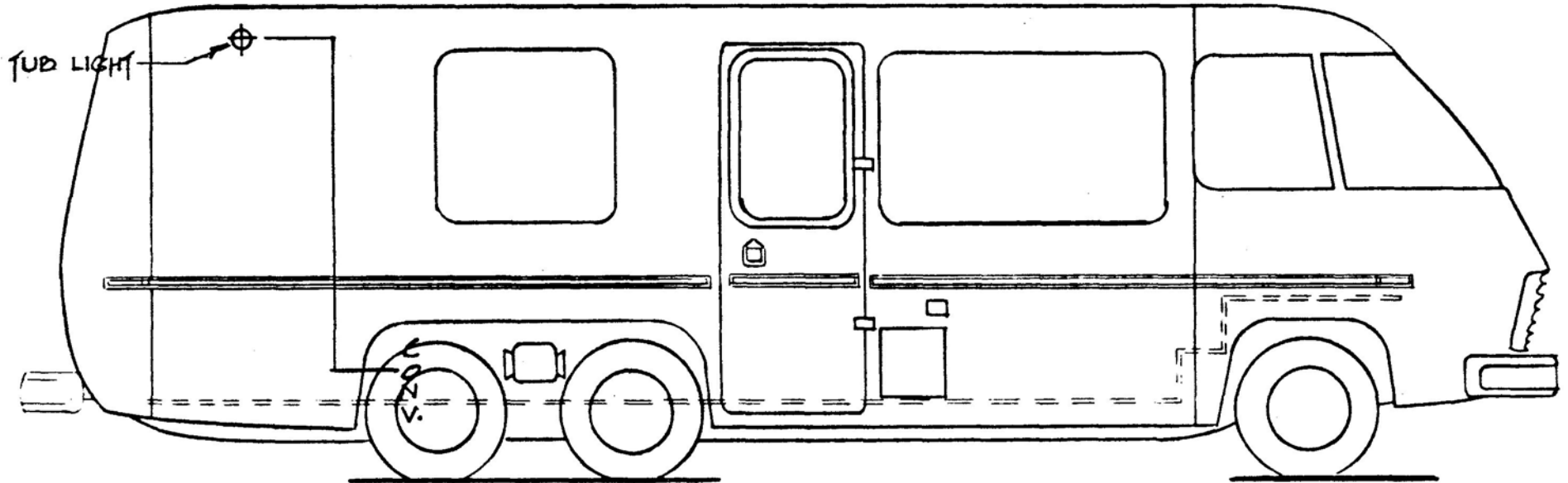

CIRCUIT #2 LIGHT & RECEPT - BLACK

AMP LOADS

1.4 PER 12V BULB

ELECTRICAL 12V.

COACHMEN INDUSTRIES, INC.

MODEL	26' RB TRANSMODE	DATE	3/1/76	DWG. NO.	J-EL-255
SUBJECT	12V. CIRCUIT #2	SCALE	NO SCALE	SHEET OF	DWG BY GRIFFIN
CHANGE NO.	DATE	BY	SER. NO.	THRU	APPD. BY

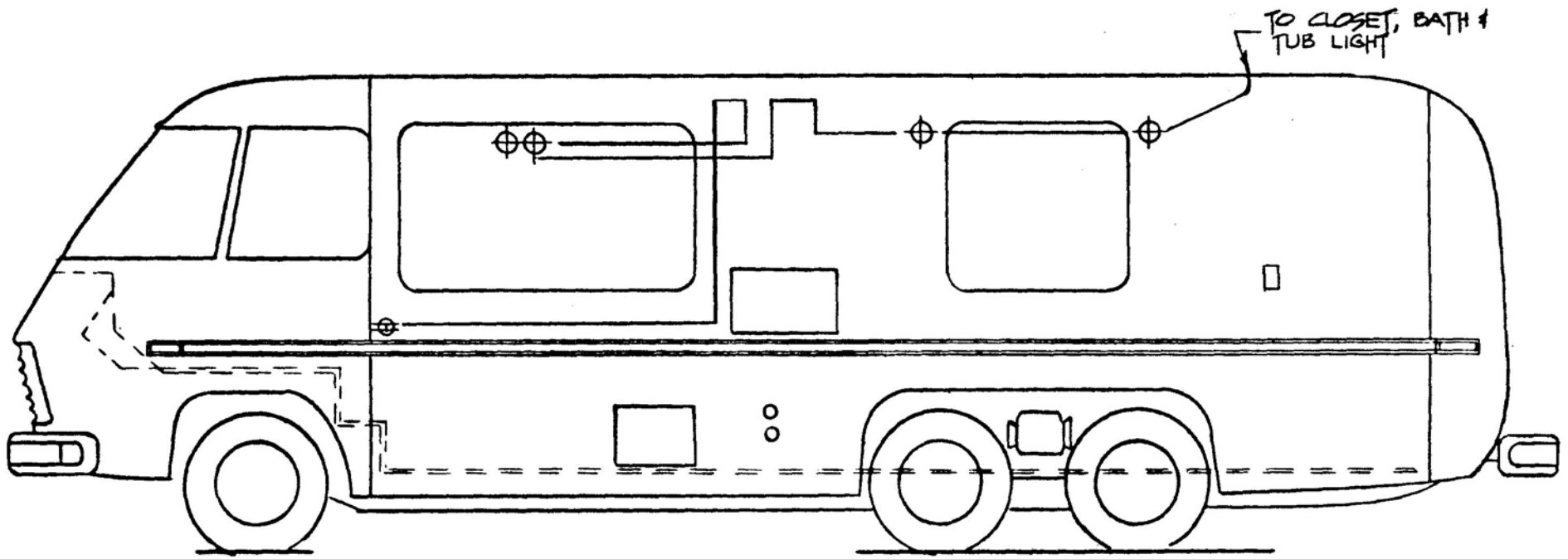

CIRCUIT #2 - LIGHT & RECEP.TS - BLACK
 AMP LOADS
 1.4 PER 12V BULB

ELECTRICAL 12V.

					COACHMEN INDUSTRIES, INC.					
					MODEL	26' RB TRANSMODE	DATE	3/1/76	DWG. NO.	J-EL-256
					SUBJECT	CIRCUIT # 2 12V.	SCALE	NO SCALE	SHEET	DWG BY
									OF	GRIFFIN
SYM	REVISIONS				CHANGE NO.	DATE	BY	SER NO	THRU	APPD. BY

CIRCUIT #4 - LIGHTS & RECEPTS - BLACK

AMP LOADS

1.4 PER 12V BULB

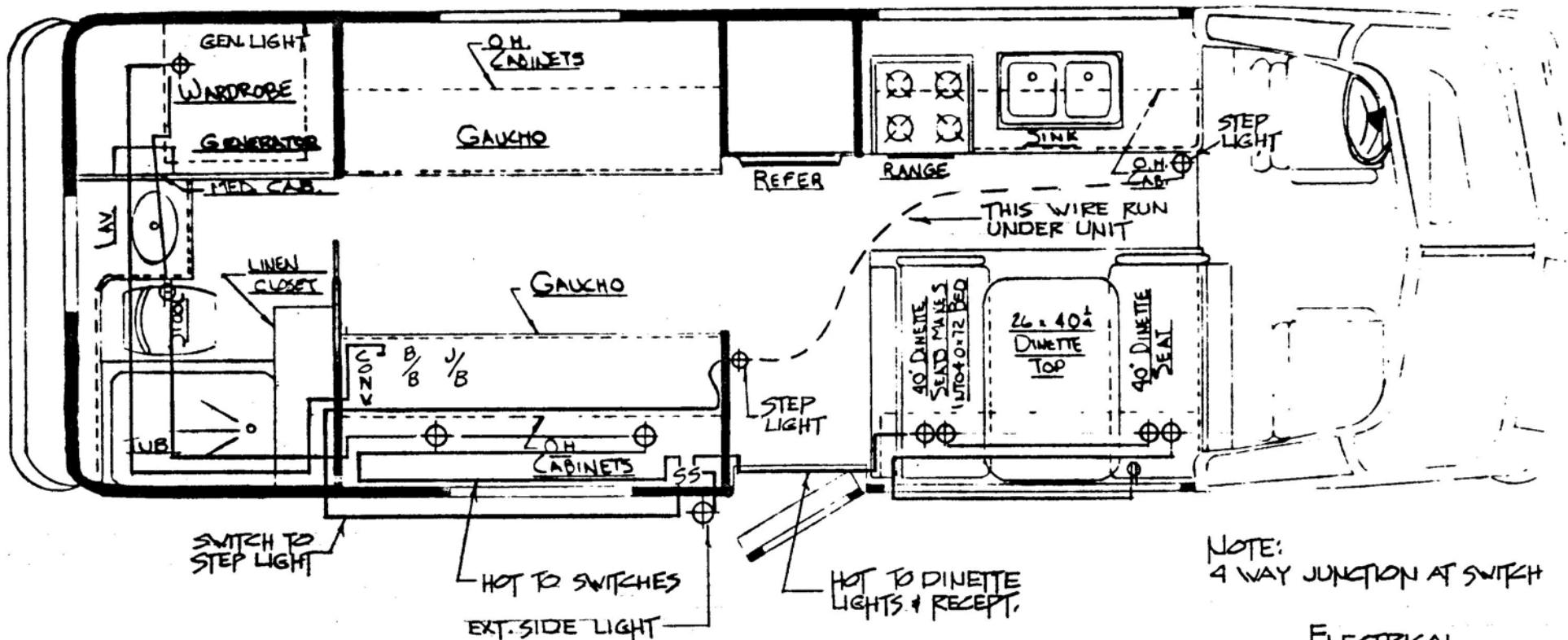

ELECTRICAL

COACHMEN INDUSTRIES, INC.

MODEL 26' RB TRANSMODE DATE 3/1/76 DWG. NO. J-EL-257

SUBJECT CIRCUIT #4 12V. SCALE NO SCALE SHEET OF DWG BY GRIFFIN

SYM	REVISIONS	CHANGE NO.	DATE	BY

SER. NO. THRU APPD. BY

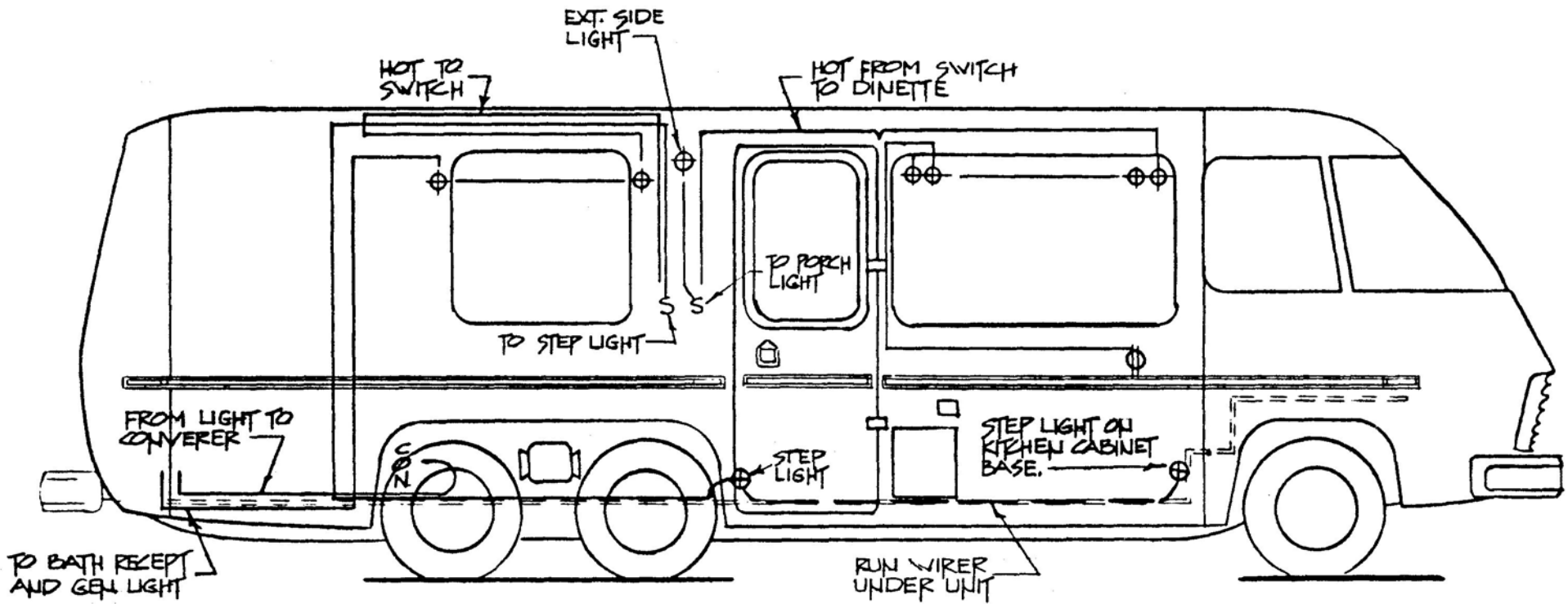

CIRCUIT #4 LIGHT & RECEPTS - BLACK 12v.
 AMP LOADS
 1.4 PER 12v. BULB

ELECTRICAL 12v.

COACHMEN INDUSTRIES, INC.

				MODEL 26' RB TRANSMODE		DATE 3/1/76		DWG. NO. J-EL-258	
				SUBJECT LIGHT & RECEPT CIRCUIT #4		SCALE NO SCALE		SHEET CF	
				DWG BY GRIFFIN					
SYM	REVISIONS	CHANGE NO.	DATE	BY	SER. NO.	THRU	APPD. BY		

TO CONVERTOR
 CIRCUIT #1 - FURNACE - BLUE
 " #5 MONITOR PANEL - GREEN
 TO MONITOR PANEL
 GEN. - RED, WHITE, BLUE, GREEN
 W/P - BLUE
 L/P - RED

AMP LOADS
 7.0 A WATER PUMP
 4.2 A FURNACE

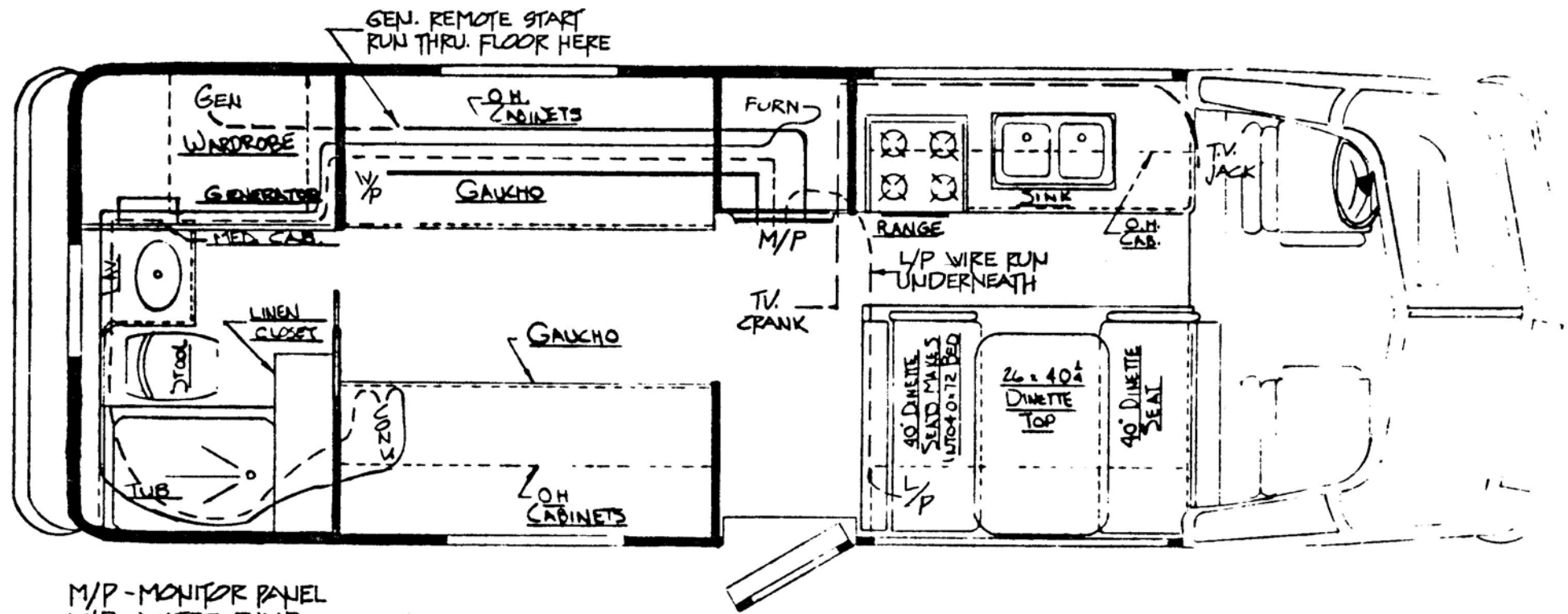

M/P - MONITOR PANEL
 W/P - WATER PUMP
 FURN. - FURNACE
 GEN. - GENERATOR
 L/P - PROPANE TANK

ELECTRICAL

COACHMEN INDUSTRIES, INC.

				MODEL	26 RB TRANSMODE	DATE	3/1/76	DWG. NO.	J-EL-262
				SUBJECT	CIRCUIT LAYOUT #1 #5	SCALE	NO SCALE	SHEET	DWG BY
								OF	GRIFFIN
SYM	REVISIONS	CHANGE NO.	DATE	BY	SER NO.	THRU	APPD. BY		

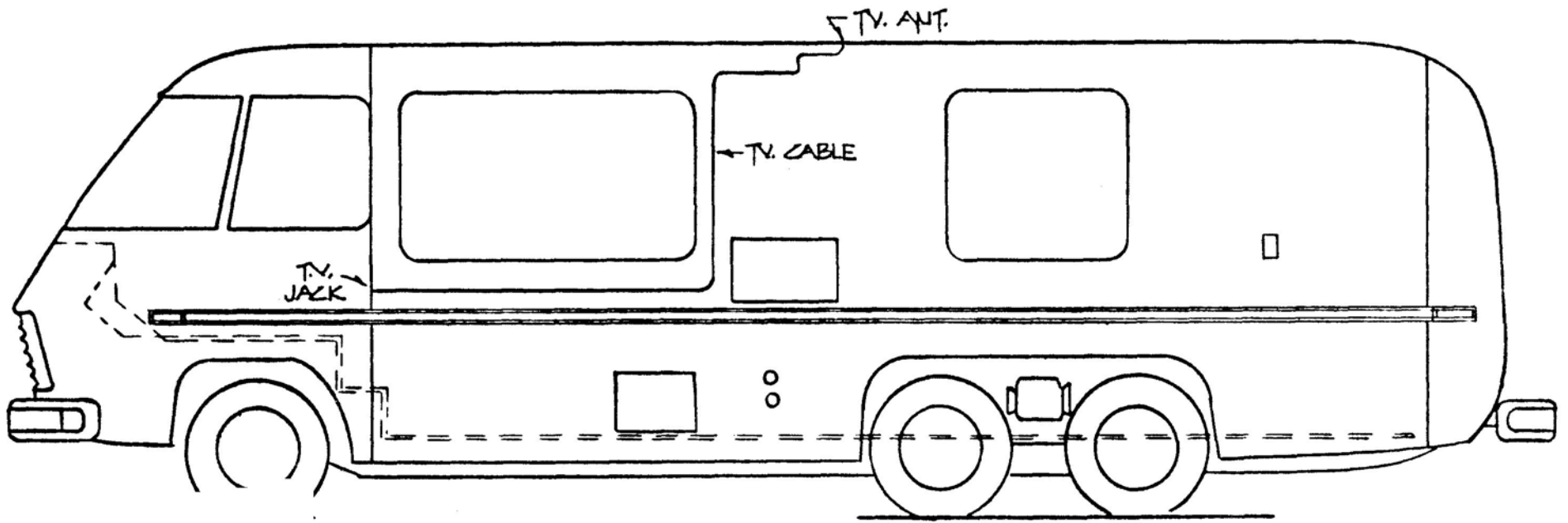

ELECTRICAL

COACHMEN INDUSTRIES, INC.

						MODEL	26 FB TRANSMODE	DATE	3/1/76	DWG. NO.	J-EL-263
						SUBJECT	T.V. CABLE.	SCALE		SHEET	DWG BY
										OF	GRIFFIN
SYM	REVISIONS	CHANGE NO.	DATE	BY	SER. NO.	THRU.					APPD. BY

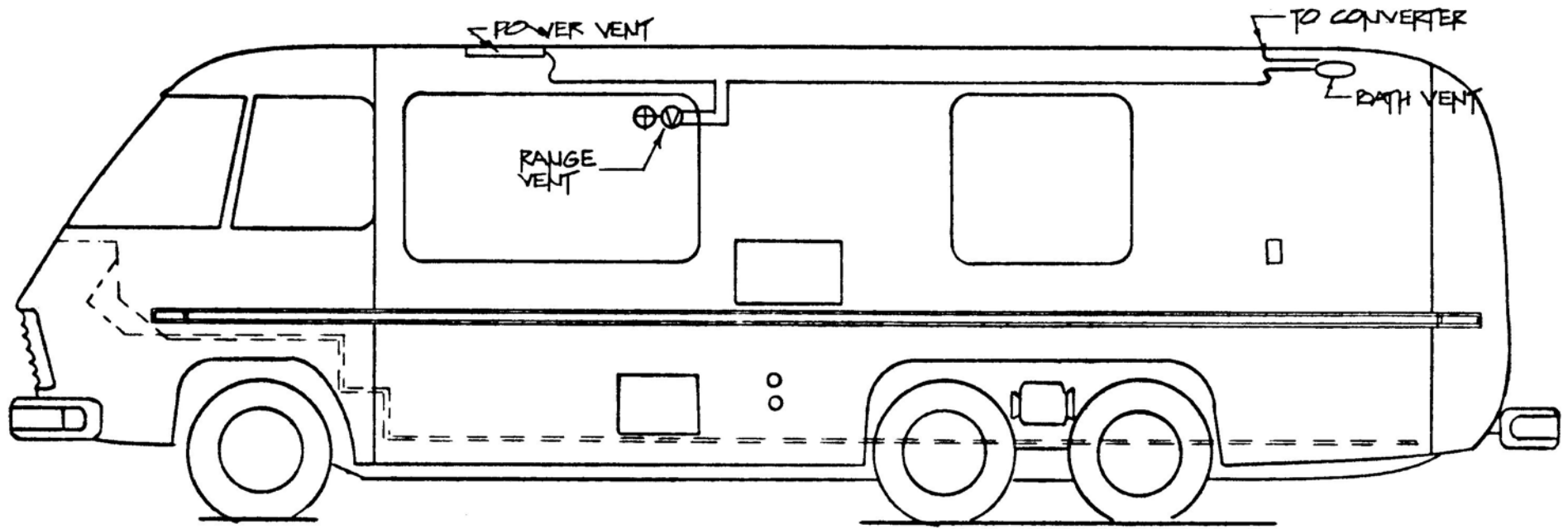

CIRCUIT #3-VENTS-RED
 AMP LOAD 5.7 RANGE HOOD
 " " 3.4 POWER VENT

ELECTRICAL

COACHMEN INDUSTRIES, INC.

						MODEL	26 RB TRANSMODE	DATE	3/1/76	DWG. NO.	J-EL-265
						SUBJECT	VENT CIRCUIT #3	SCALE	RD SALE	SHEET	DWG BY
										OF	GRIFFIN
SYM	REVISIONS	CHANGE NO.	DATE	BY	SER NO.	THRU	APPD. BY				

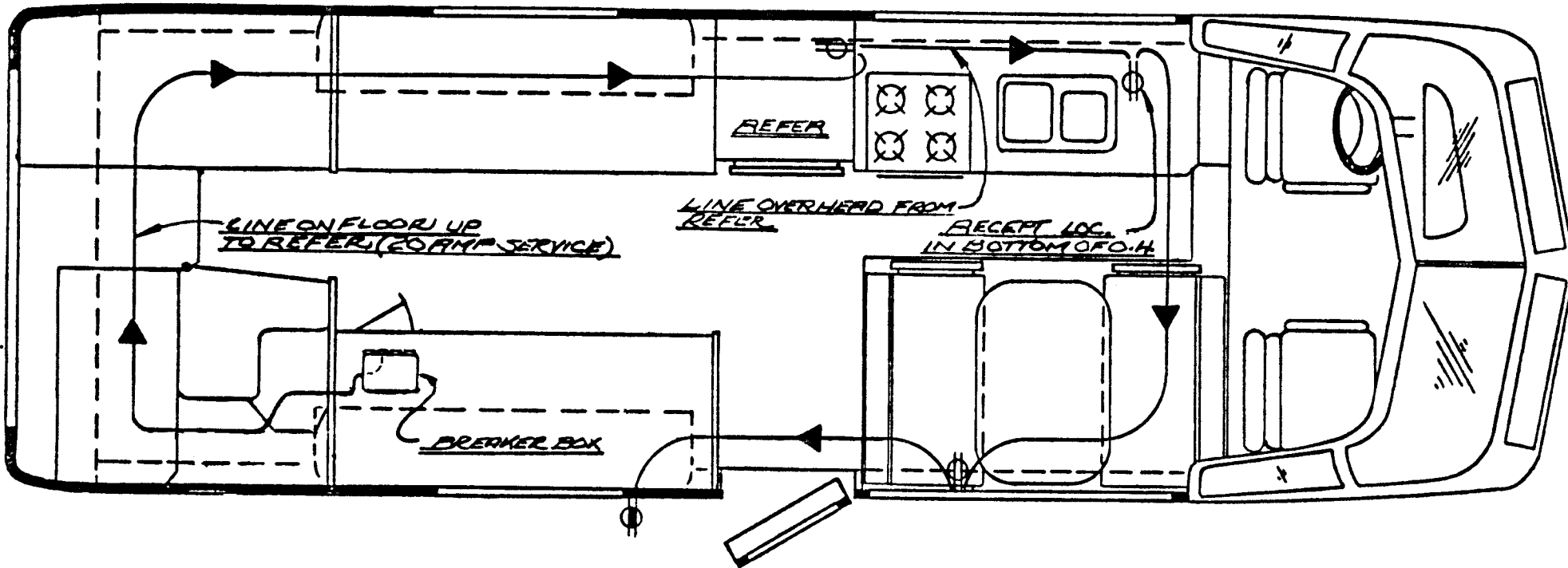

- ⊕ INTERIOR RECEPT 110V. 12-2 WIRE
- ⊖ EXTERIOR RECEPT W/GROUND FAULT 110V. 12-2 WIRE

MAIN IS 10-2 110V.

COACHMEN INDUSTRIES, INC.

MOD. 26 RB TRANSMODE

DATE 9-4-75

DWG. NO. RBEL-261000

SUBJECT 110V. ELECTRICAL LINE 1

SCALE ~

SHEET 1
of 2

DWG BY
S. STOVER

SYM	REVISIONS	CHANGE NO.	DATE	BY	SER. NO.	THRU.	APPD. BY

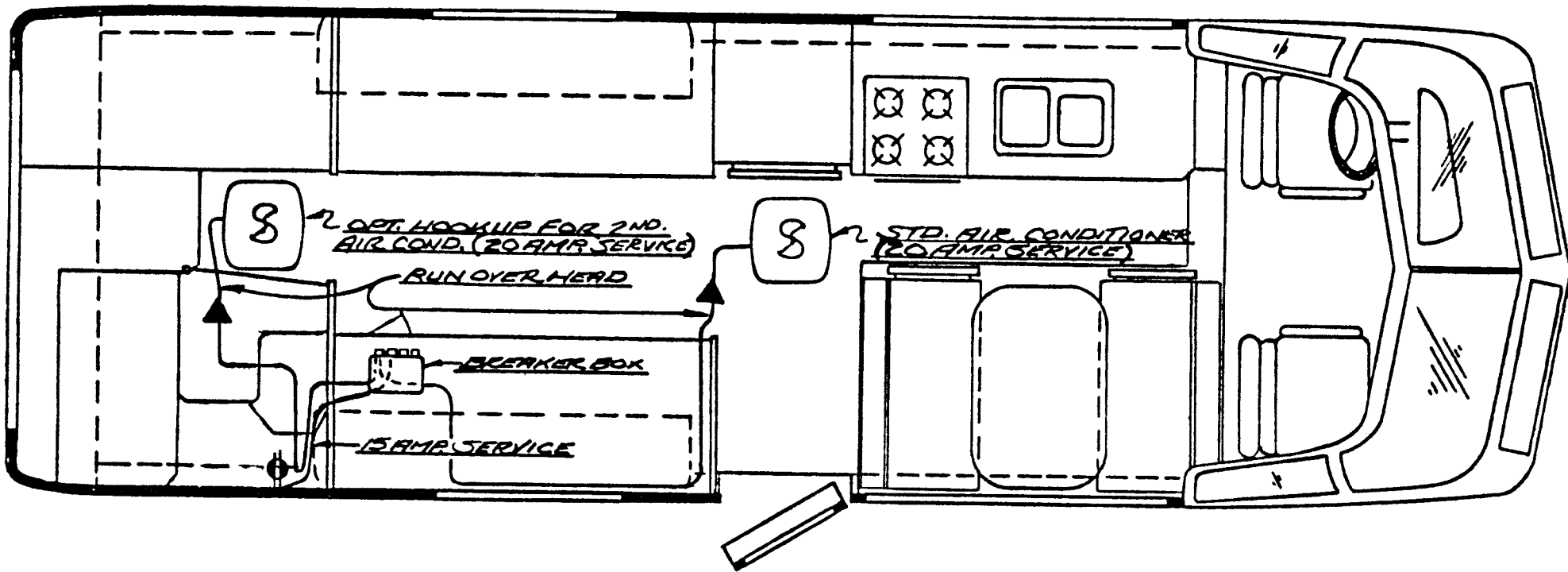

⊕ INTERIOR RECEPT W/GROUND FAULT BREAKER

MAIN IS 10-2 110V.

COACHMEN INDUSTRIES, INC.

MODEL	26' RB TRANS MODE	DATE	9-4-75	DWG. NO.	REBEL-261000
SUBJECT	110 V. ELECTRICAL LINES #2, #3, #4	SCALE	~	SHEET	2
SER. NO.		THRU.		OF 2	DWG. BY S. STOVER
					APPD. BY

SYM	REVISIONS	CHANGE NO.	DATE	BY

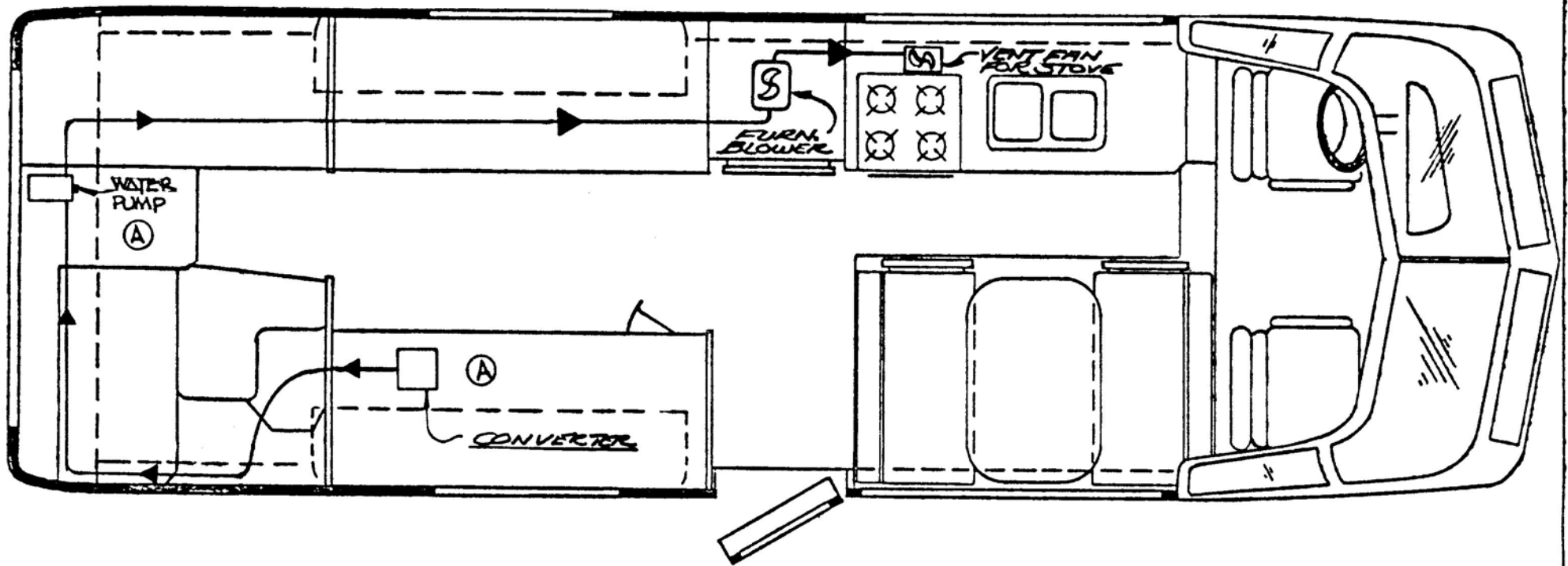

COACHMEN INDUSTRIES, INC.

					MODEL <i>26RB TRANS MODE</i>	DATE <i>9-3-75</i>	DWG. NO. <i>REBEL-261004-A</i>
					SUBJECT <i>12 V. ELECTRICAL LINE #4</i>	SCALE <i>~</i>	SHEET <i>4</i> OF <i>4</i>
<i>A.</i>	<i>RELOCATE W/P & CONVERTER</i>		<i>5-11-77</i>	<i>JIS</i>			DWG. BY <i>D. STOVER</i>
SYM	REVISIONS	CHANGE NO.	DATE	BY	SER. NO.	THRU	APPD. BY